

# SubConn® Micro Low Profile

## 3 contacts

### Connector specifications

Voltage rating	300 V DC/AC rms
Current rating	5 A per contact (max 10 A per connector)
Insulation resistance	> 200 Mohm
Contact resistance	< 0.01 ohm
Wet matings	> 500 (open face rated)
Temperature rating (water)	- 4 to 60°C, 25 to 140°F
Temperature rating (air)	- 40 to 60°C, - 40 to 140°F
Storage temperature rating	- 40 to 60°C, - 40 to 140°F
Qualified pressure tested	800 bar, 11,600 psi
Depth rating PEEK	300 bar, 4,350 psi

### Material specifications

Connector body	Chloroprene rubber
Bulkhead body	Brass or stainless steel
Contacts	Female sockets in gold plated brass UNS - C36000 Male pins in gold plated beryllium copper
O-rings	Nitrile
Locking strap	Chloroprene rubber
Inline cable (2 ft, 60 cm)	20 AWG, 0.52 mm <sup>2</sup> synthetic rubber
Bulkhead leads (1 ft, 30 cm)	20 AWG, 0.52 mm <sup>2</sup> coloured PTFE

### Face view (male)



### Inline cable colour code

- 1 Black
- 2 White
- 3 Red

### Nominal cable outside diameter (OD)

3 conductor cable 0.250", 6.35 mm

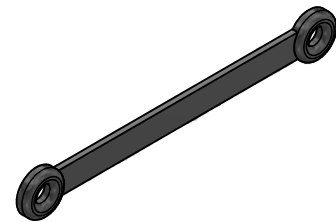
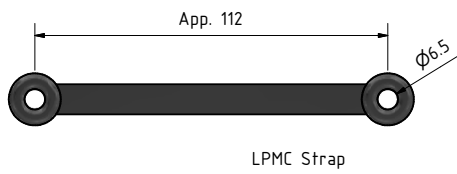
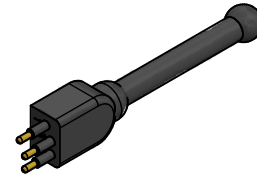
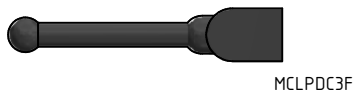
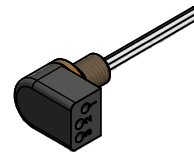
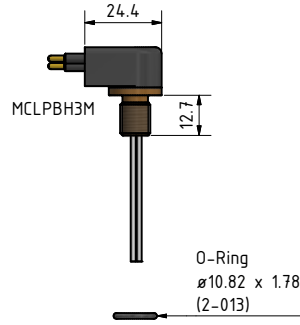
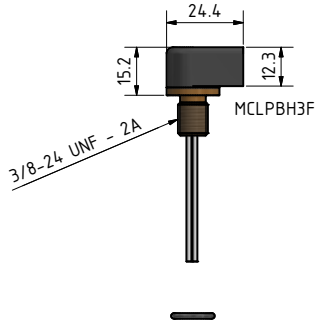
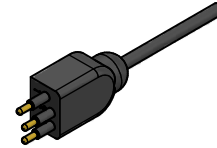
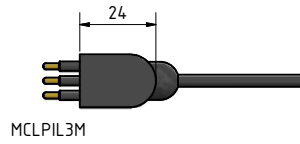
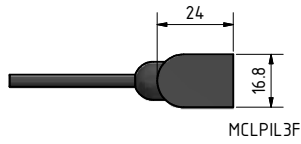

**Drawing information**

Dimensions in mm (1 mm = 0.03937 inch)  
Threads in inches (1 inch = 25.4 mm)